



<b>UK</b>	WELDED STEEL FRAME INSTALLATION INSTRUCTION
<b>SE</b>	SVETSAD STÅLKARM MONTERINGSANVISNING
<b>NO</b>	SVEISET STÅLKARM MONTERINGSANVISNING
<b>DK</b>	SVEJST STÅLKARM MONTAGEVEJLEDNING

Thank you for choosing  
a **JELD-WEN** product!

UK  
DK  
NO  
SE

TOOLS REQUIRED  
VÆRKTØJ, DU SKAL BRUGE  
VERKTØY DU BEHØVER  
VERKTYG SOM DU BEHÖVER

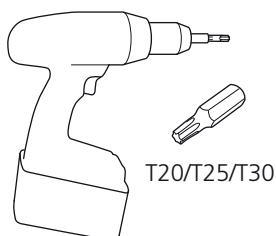
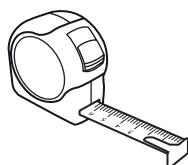
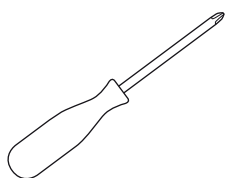

T20/T25/T30

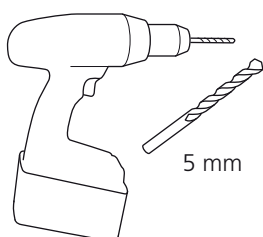

5 mm

---







<b>UK</b>	INSTALLATION INSTRUCTION SINGLE DOOR
<b>SE</b>	MONTERINGSANVISNING ENKELDÖRR
<b>NO</b>	MONTERINGSANVISNING ENKELDØRER
<b>DK</b>	MONTAGEVEJLEDNING ENKELT DØRE

---





UK  
SE  
NO  
DK

ACCESSORIES NOT INCLUDED, BUT REQUIRED  
TILLBEHÖR SOM BEHÖVS MEN SOM EJ INGÅR  
TILBEHØR SOM IKKE FØLGER MED, MEN NØDVENDIG  
NØDVENDIGT TILBEHØR, SOM IKKE MEDFØLGER

				Unclassified Oklassad Uklassifiseret Uklassificeret
 Stone Wool min. 100 kg/m <sup>3</sup>	●	●	●	
	●	●	●	●
		●	●	





UK  
SE  
NO  
DK

ACCESSORIES NOT INCLUDED, BUT REQUIRED  
FOR SPECIFIC CONSTRUCTIONS  
TILLBEHÖR SOM EJ INGÅR, MEN SOM BEHÖVS  
VID SPECIFIKÅ KONSTRUKTIONER  
NØDVENDIG TILBEHØR, SOM IKKE MEDFØLGER,  
TIL SPESIFIKKE KONSTRUKSJONER  
NØDVENDIGT TILBEHØR, SOM IKKE MEDFØLGER,  
TIL SPECIFIKKE KONSTRUKTIONER

 Ø6,0x60mm	●	●	●	●
 M3x25mm	●	●	●	●

UK  
SE  
NO  
DK

ACCESSORIES INCLUDED  
TILLBEHÖR SOM INGÅR  
TILBEHØR SOM FØLGER MED  
TILBEHØR SOM MEDFØLGER

 Ø7,5x65mm	●	●	●	●
 Ø6,0x65mm	●	●	●	●
	●	●	●	●
*  Ø4,8x19mm	●	●	●	●
* 	●	●	●	●

\* UK  
SE  
NO  
DK

INCLUDED FOR SPECIFIC FRAME MODELS  
INKLUDEERAT FÖR VISSA KARMMODELLER  
INKLUDERT FOR SPESIFIKKE KARMMODELLER  
MEDFØLGER TIL NOGLE KARMTYPER

1

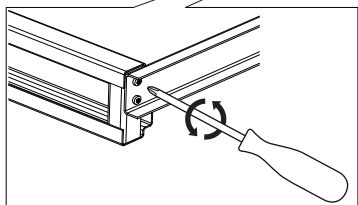
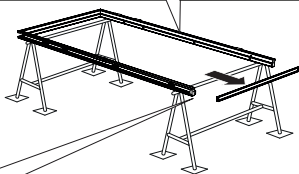
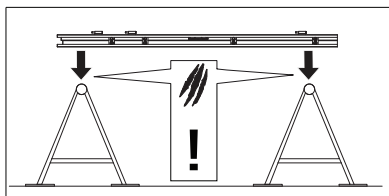

2

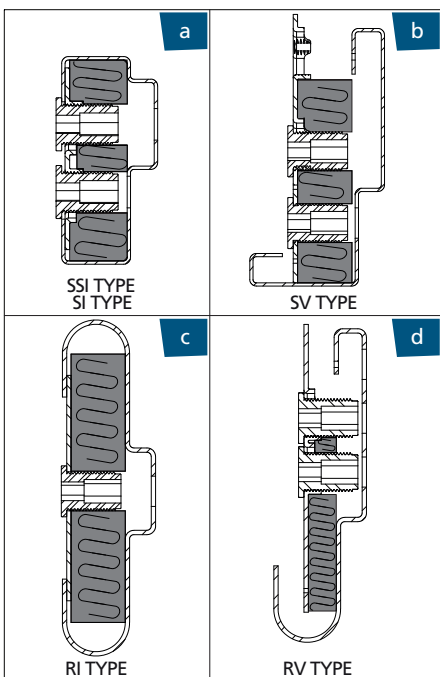

Unclassified  
Oklassad  
Uklassifisert  
Uklassificeret

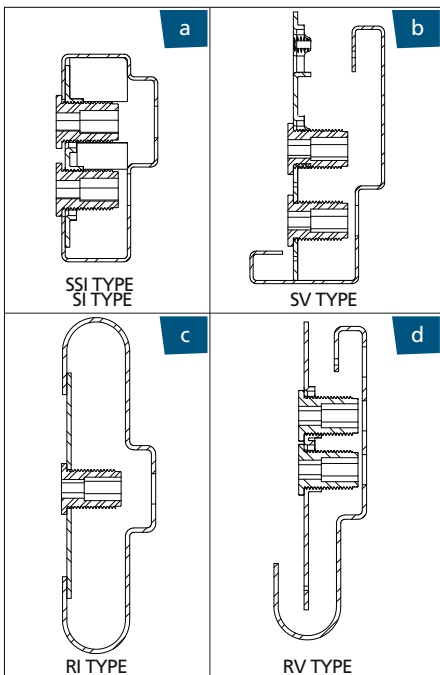

3

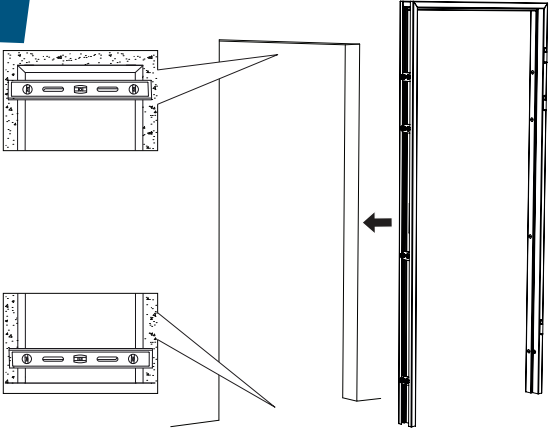

4



10mm

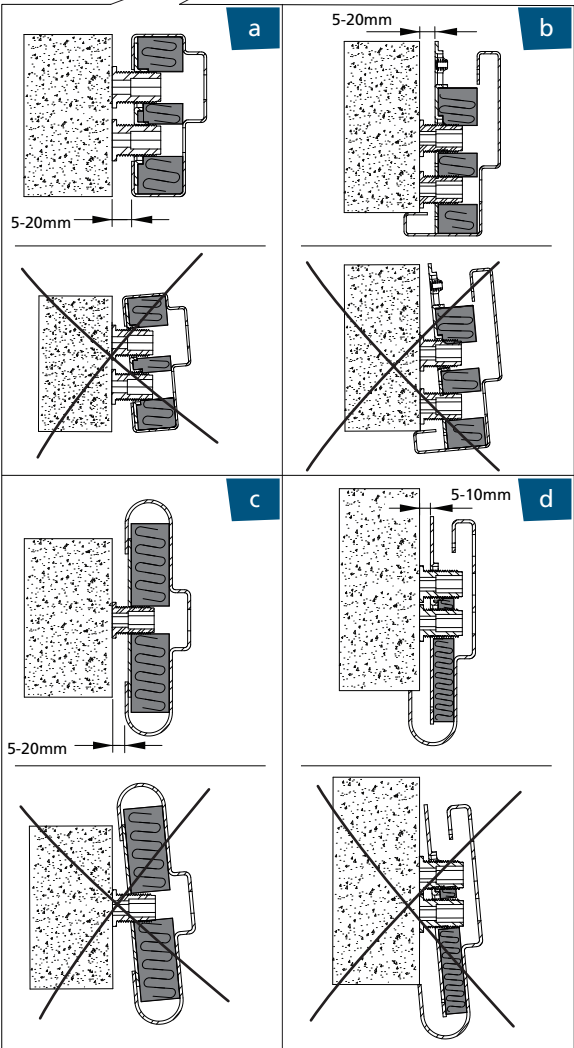
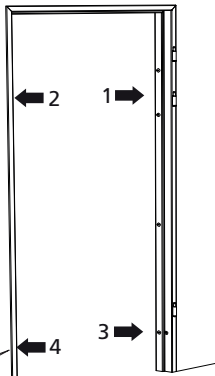

5

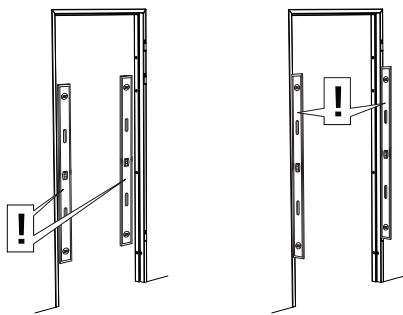
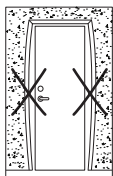

6

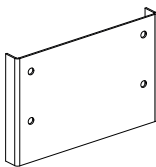
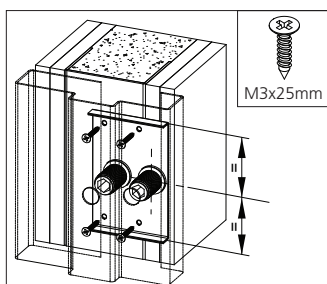
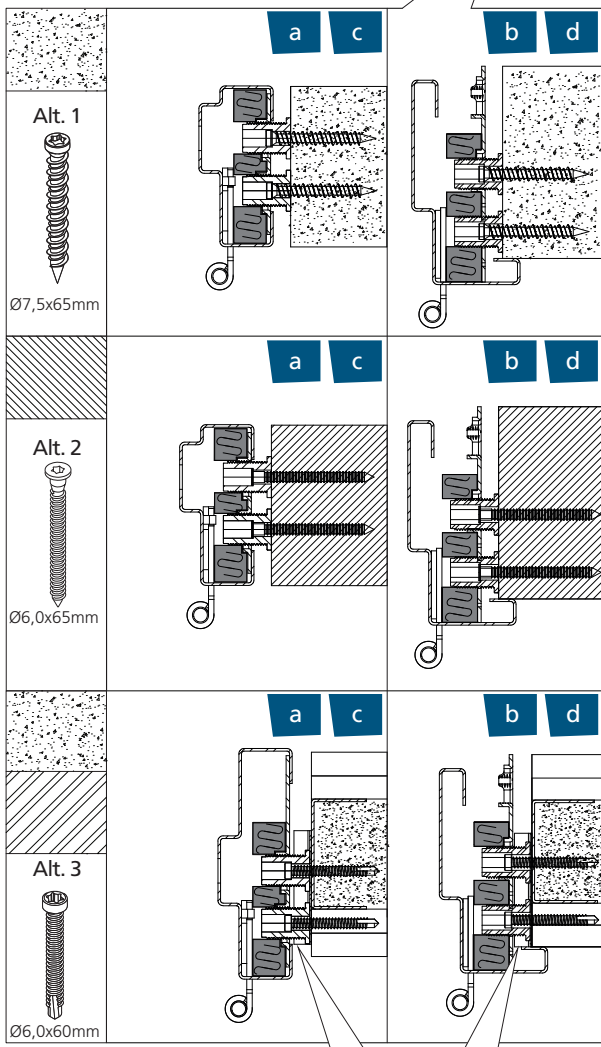
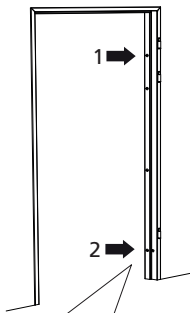
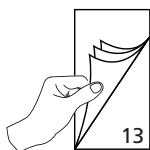

UK INCLUDED FOR SPECIFIC FRAME MODELS  
 SE INKLUDERAT FÖR VISSA KARMODELLER  
 NO INKLUDERT FOR SPESIFIKKE KARMODELLER  
 DK MEDFØLGER TIL NOGLE KARMTYPER

7

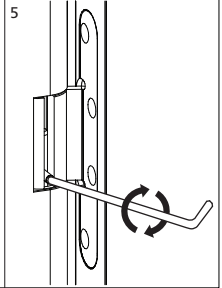
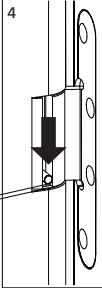
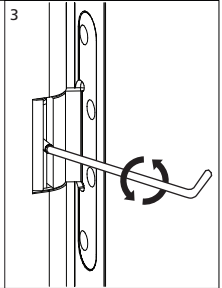
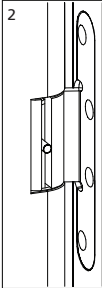
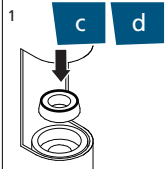
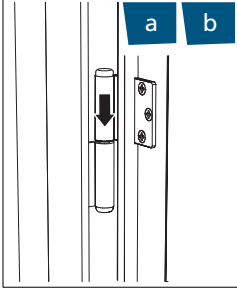
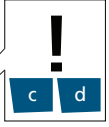
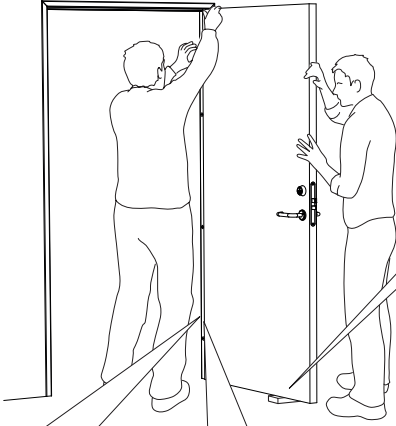



8

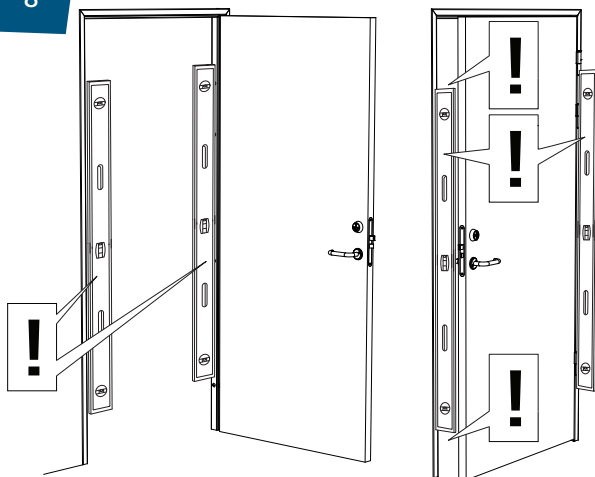

9

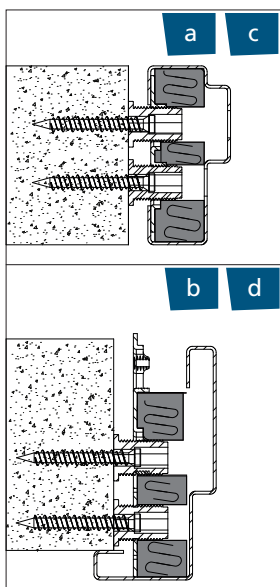

3

4

Ø7,5x65mm

10



10 mm

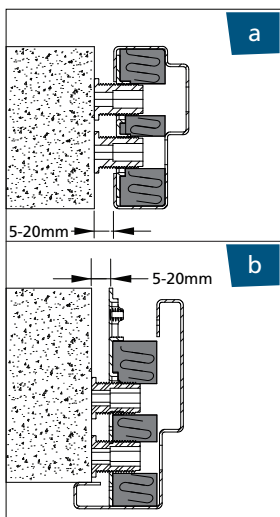

5

6

7

8

11

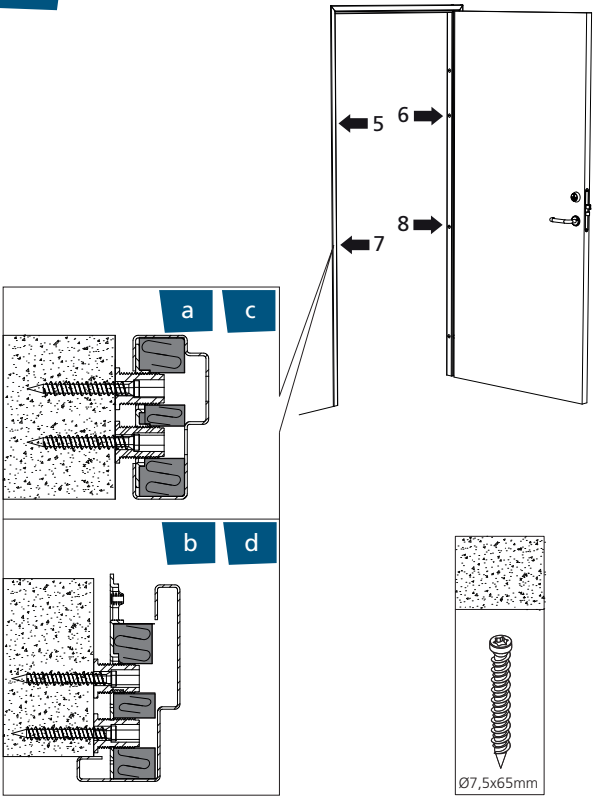

12

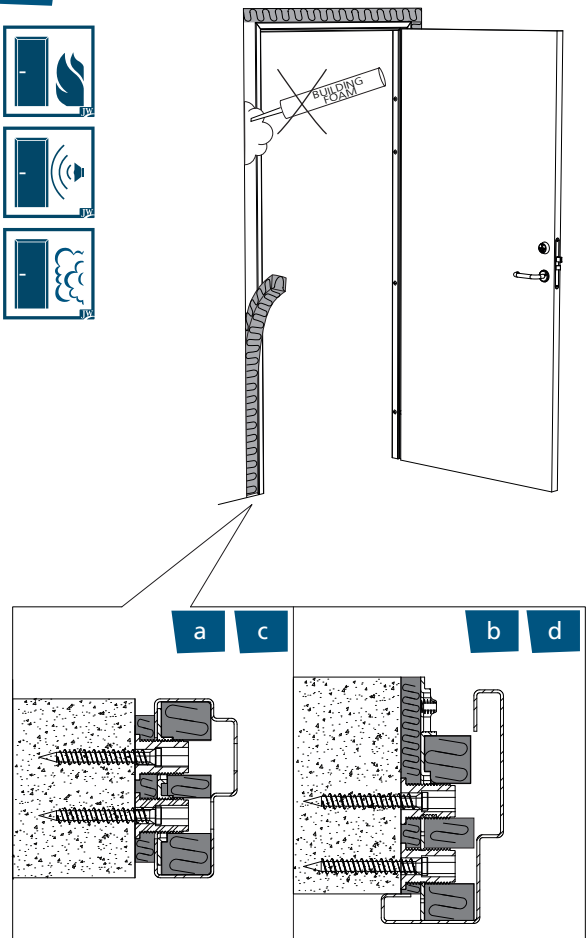

13

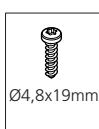
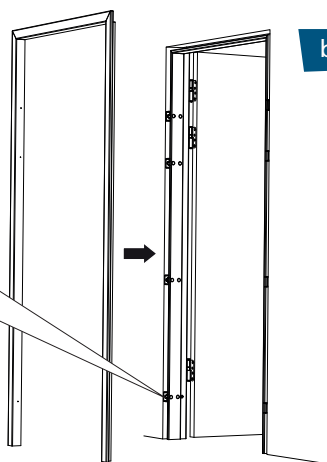
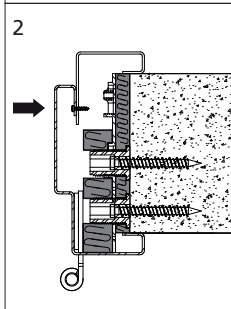
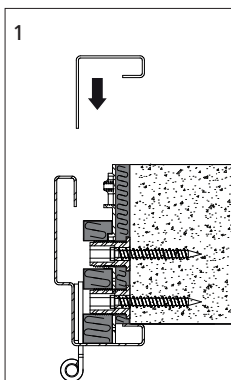

14

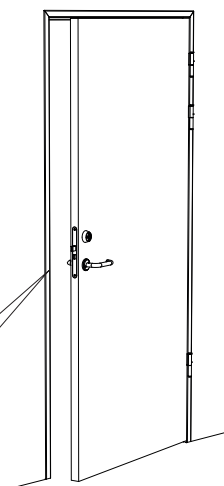
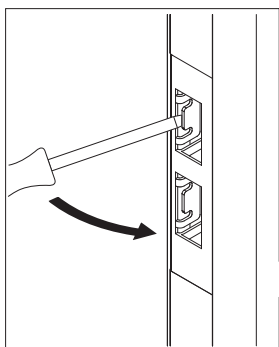

15

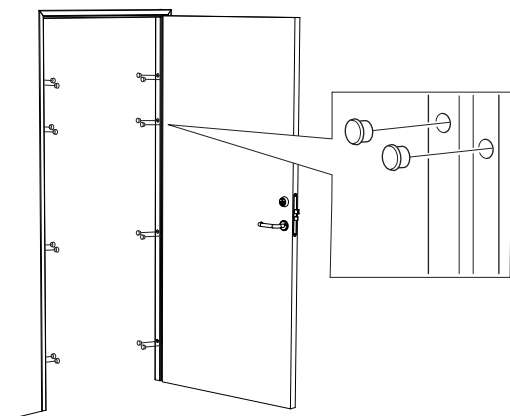

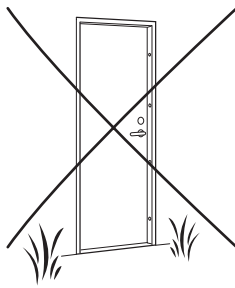
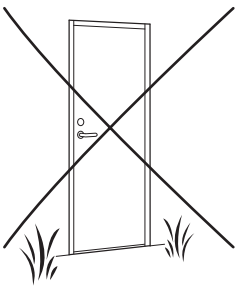
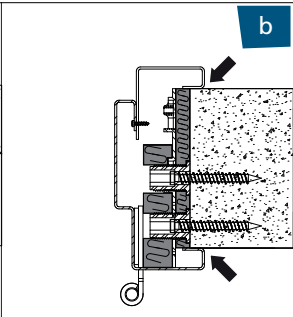
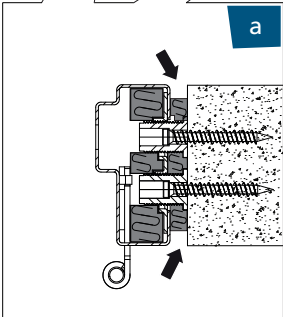
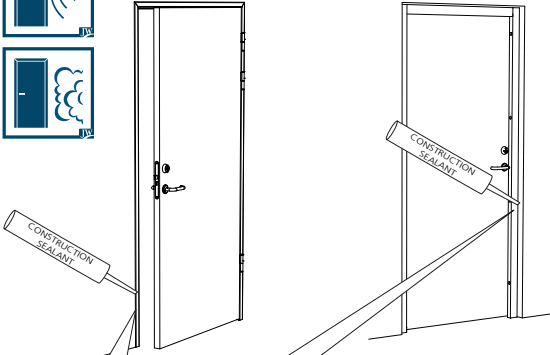

**UK:** Reference to mounting details, illustration 6 on page 7:  
Density and stability of wall constructions can vary, why the supplied screws may not always give a durable stabile mounting. Use if necessary, longer screws, plugs, and/or ensure a reinforcement of the wall construction.

**DK:** Henvisning til monteringsdetaljer, illustration 6 på side 7:  
Densitet og stabilitet i vægkonstruktioner kan variere, hvorfor de medfølgende skruer ikke i alle situationer kan give en holdbar og stabil montering. Brug om nødvendigt længere skruer, plugs, og/eller sørg for en forstærkning af vægkonstruktionen.

**SE:** Hänvisning till monteringsdetaljer, illustration 6 på sidan 7:  
Väggkonstruktioners densitet och stabilitet kan variera, varför de medföljande skruvarna inte alltid ger ett hållbart och stabilt montage. Om så krävs, använd längre skruvar, plugg och/eller se till att förstärka väggkonstruktionen.

**NO:** Henvisning til monteringsdetaljer, illustrasjon 6 på side 7:  
Densitet og stabilitet av veggkonstruksjoner kan variere, kan medføre at medsendte skruer ikke alltid vil gi en holdbar stabil montering. Ved behov bruk lengre skruer, kiler og/eller sørg for en forsterket veggkonstruksjon.





Thank you for choosing  
a **JELD-WEN** product!

